

Plastic shell外壳

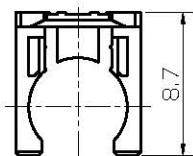

Snap ring卡环

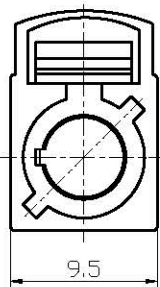
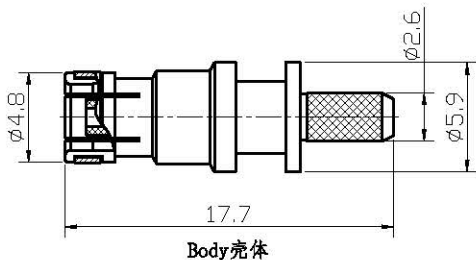

Body壳体

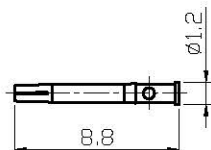

Pin contact中心针

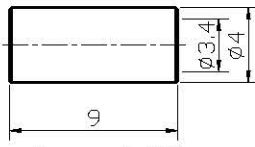

Copper tube铜管

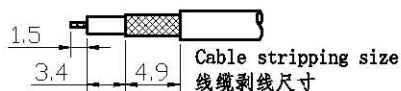

Cable stripping size  
线缆剥线尺寸

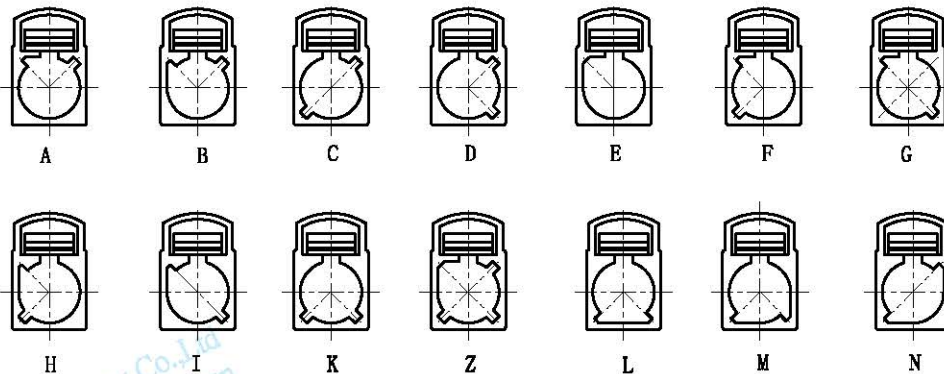

Port Type

Package:

1. Copper: 100pcs/PE bag;
2. Pin contact: 100pcs/PE bag;
3. Body: 100pcs/PE bag;
4. Snap ring: 100pcs/PE bag;
5. Plastic shell 100pcs & above parts/PE bag;
6. Carton: Yellow Corrugated Carton.

包装:

1. 铜管: 100pcs/PE袋;
2. 中心针: 100pcs/PE袋;
3. 五金壳: 100pcs/PE袋;
4. 卡扣: 100pcs/PE袋;
5. 塑胶壳100pcs+以上配件/PE袋;
6. 外箱: 黄色瓦楞纸箱。

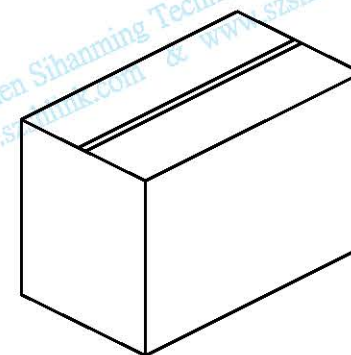
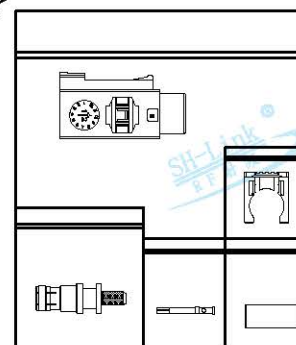
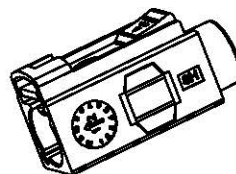

NO	DESCRIPTION描述	MATERIAL材质	SPECIFICATION规格	QTY数量
7	Plastic shell外壳	PA66+30%GF		1
6	Snap ring卡环	PA66+30%GF		1
5	Snap ring卡圈	Beryllium copper铍铜		1
4	Copper tube铜管	Brass黄铜	Nickel plated镀镍	1
3	Insulator绝缘体	PTFE聚四氟乙烯		1
2	Pin contact中心针	Beryllium copper铍铜	Gold plated镀金	1
1	Body壳体	Brass黄铜	Nickel plated镀镍	1
				1

LIMITS		A(±)	B(±)	C(±)	D(±)	E(±)	F(±)
0-6	0.03	0.05	0.08	0.10	0.15	0.20	0.25
6-18	0.05	0.08	0.10	0.15	0.20	0.25	0.35
18-30	0.08	0.10	0.15	0.20	0.25	0.30	0.50
30-50	0.10	0.15	0.20	0.25	0.30	0.50	0.65
50-80	0.15	0.20	0.25	0.35	0.50	0.65	0.80
80-120	0.20	0.25	0.30	0.50	0.65	0.80	0.95
120-180	0.25	0.35	0.50	0.65	0.80	0.95	1.15
180-250	0.35	0.50	0.65	0.95	0.95	1.15	

SIGNATURE 作成日期		SH-Link® 深圳市思翰铭科技有限公司	
DATE 2018.07.26		RF 射频 Shenzhen Sihanming Technology Co.,Ltd	
DRAWN BY 陈燕荣	SCALE 比例 2:1	WEIGHT 重量(g) 3.6	PERSPECTIVE 视角方法
CHECKED BY	ITEM NO 品号 SHM. 900. 0007-11		PART DESCRIPTION 品名 FAKRA SMB-C-K1. 5-24
APPROVED BY			