

NO	Change Date	Change No.	Change content	Change person	version
△	2021.07.27	ECN20210727026	中心针总长11.7变更为11.3;	郑婉洵	B

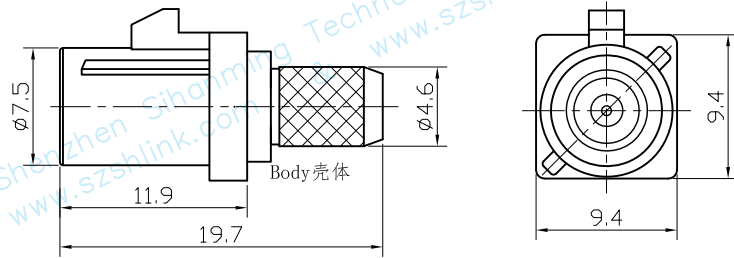

Plastic shell外壳

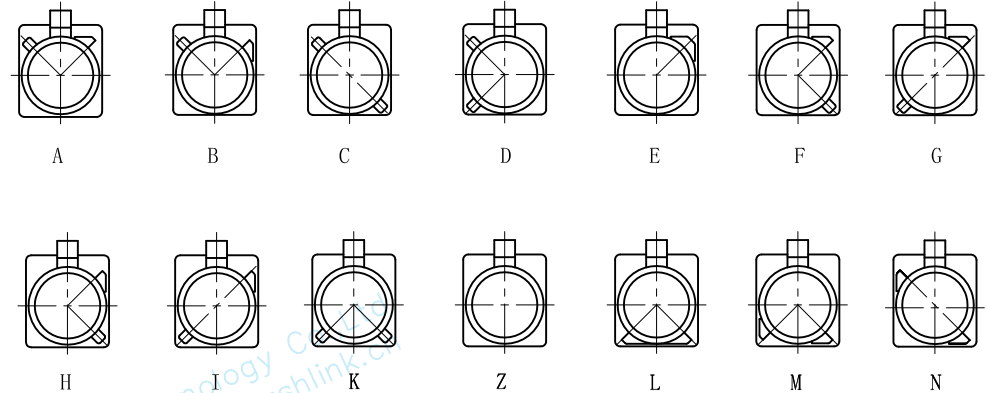

Port Type

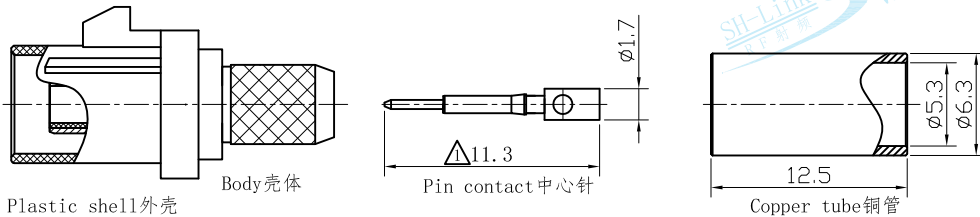

Plastic shell外壳

Body壳体

Pin contact中心针

Copper tube铜管

Package:

1. Copper: 100pcs/PE bag;
2. Pin contact: 100pcs/PE bag;
3. Plastic shell 100pcs & above parts/PE bag;
4. Carton: Yellow Corrugated Carton.

包装:

1. 铜管: 100pcs/PE袋;
2. 中心针: 100pcs/PE袋;
3. 塑胶五金壳100pcs+以上配件/PE袋;
4. 外箱: 黄色瓦楞纸箱.

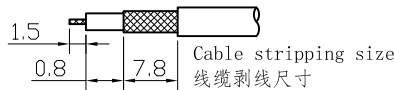
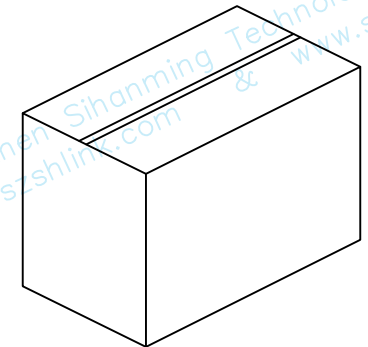
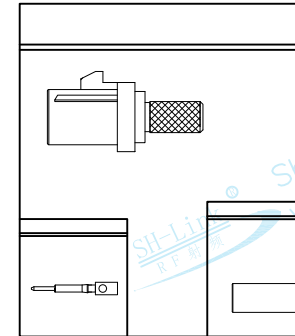
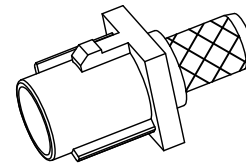

Cable stripping size
线缆剥线尺寸

- 技术要求:
1. 适配线缆: RG58
 2. 符合ROHS标准;
 3. 未注公差参考: 未注公差尺寸对照表.

NO	DESCRIPTION描述	MATERIAL材质	SPECIFICATION规格	QTY数量
7				
6				
5	Plastic shell外壳	PA66+30%GF		1
4	Copper tube铜管	Brass 黄铜	Nickel plated 镀镍	1
3	Insulator绝缘体	PTFE聚四氟乙烯		1
2	Pin contact中心针	Brass 黄铜	Gold plated 镀金	1
1	Body 壳体	Brass 黄铜	Nickel plated 镀镍	1

Limits unit:mm	E(±)
0-6	0.15
6-18	0.20
18-30	0.25
30-50	0.30
50-80	0.50
80-120	0.65
120-180	0.80
180-250	0.95

SIGNATURE DATE作成日期		SH-Link® 深圳市思翰铭科技有限公司 RF 射频 Shenzhen Sihanming Technology Co., Ltd	
DRAWN BY	郑婉洵	SCALE 比例	2:1
CHECKED BY		WEIGHT 重量(g)	2.8
APPROVED BY		PERSPECTIVE 视角方法	
		ITEM NO 品号	PART DESCRIPTION 品名
		SHM. 900. 0004-3. X. X. A-XX (XXX)	FAKRA SMB-C-J3-X-2